

LIQUID CAPACITY TO BOTTOM OF OUTLET: 544 GALLONS
 GALLONS PER INCH: 13.4
 LID THICKNESS: 5" WITH 1" RECESS
 MAX BURIAL DEPTH: 9'

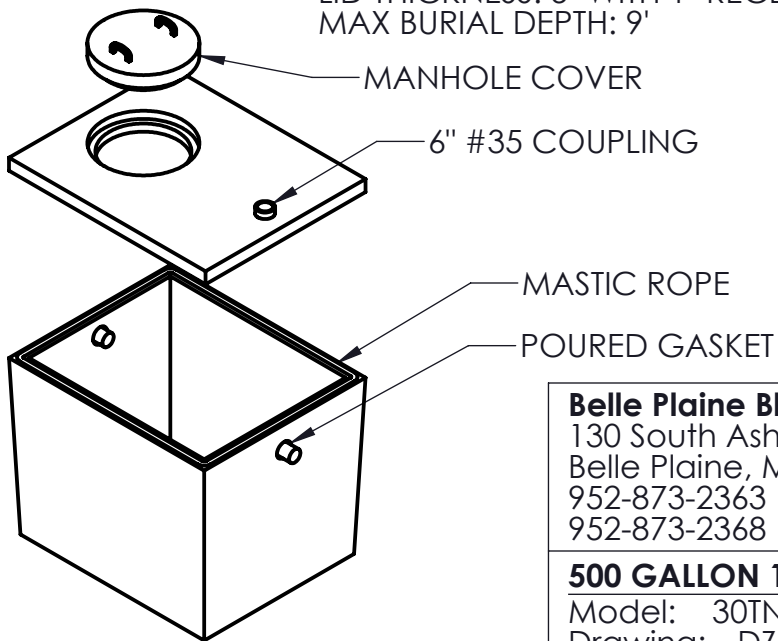

Belle Plaine Block & Tile

130 South Ash
 Belle Plaine, MN 56011
 952-873-2363
 952-873-2368 (fax)

500 GALLON 1-COMPARTMENT PUMP TANK

Model: 30TNKPUMP500
 Drawing: DZ-500 SINGLE
 Drawn By: DJP

Date: 10/24/2012